

- NOTES:
- MATERIAL:
    - HOUSING: THERMOPLASTIC, HIGH TEMP.,UL94V-0;
    - CONTACT: COPPER ALLOY
    - FITTING NAIL:COPPER ALLOY
    - LATCH: THERMOPLASTIC, HIGH TEMP.,UL94V-0;
  - FINISH:
    - CONTACT:
      - 50u" MIN. NICKEL UNDER PLATING
      - GOLD FLASH PLATING
    - FITTING NAIL:
      - 50u" MIN. NICKEL UNDER PLATING
      - 50u" MIN. MATTE TIN PLATING
  - REFLOW SOLDER CAPABLE TO 260°C PER ACES SPEC.
  - SPEC. PLS. REFER TO PS-51619-XXXX-XXX
  - PACKAGE PLS. REFER TO 51522-XXXX7-TRP
  - PART NUMBER

NO OF CKT	51652-XXX X	X-XXX	XXX	HOUSING COLOR	ACTUATOR COLOR
PACKING	0: TAPE & REEL	1: TUBE	001	BLACK	NATURAL
PLATING					
1: GOLD FLASH (LEAD FREE)					
N: MATT TIN (LEAD FREE)					

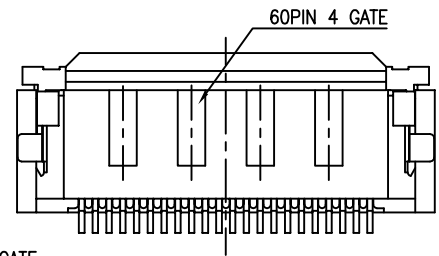

CKT	Dim A	Dim B	Dim C	CKT	Dim A	Dim B	Dim C
4	1.50	2.56	6.2	33	16.00	17.06	20.7
5	2.00	3.06	6.7	34	16.50	17.56	21.2
6	2.50	3.56	7.2	35	17.00	18.06	21.7
7	3.00	4.06	7.7	36	17.50	18.56	22.2
8	3.50	4.56	8.2	37	18.00	19.06	22.7
9	4.00	5.06	8.7	38	18.50	19.56	23.2
10	4.50	5.56	9.2	39	19.00	20.06	23.7
11	5.00	6.06	9.7	40	19.50	20.56	24.2
12	5.50	6.56	10.2	41	20.00	21.06	24.7
13	6.00	7.06	10.7	42	20.50	21.56	25.2
14	6.50	7.56	11.2	43	21.00	22.06	25.7
15	7.00	8.06	11.7	44	21.50	22.56	26.2
16	7.50	8.56	12.2	45	22.00	23.06	26.7
17	8.00	9.06	12.7	46	22.50	23.56	27.2
18	8.50	9.56	13.2	47	23.00	24.06	27.7
19	9.00	10.06	13.7	48	23.50	24.56	28.2
20	9.50	10.56	14.2	49	24.00	25.06	28.7
21	10.00	11.06	14.7	50	24.50	25.56	29.2
22	10.50	11.56	15.2	51	25.00	26.06	29.7
23	11.00	12.06	15.7	52	25.50	26.56	30.2
24	11.50	12.56	16.2	53	26.00	27.06	30.7
25	12.00	13.06	16.7	54	26.50	27.56	31.2
26	12.50	13.56	17.2	55	27.00	28.06	31.7
27	13.00	14.06	17.7	56	27.50	28.56	32.2
28	13.50	14.56	18.2	57	28.00	29.06	32.7
29	14.00	15.06	18.7	58	28.50	29.56	33.2
30	14.50	15.56	19.2	59	29.00	30.06	33.7
31	15.00	16.06	19.7	60	29.50	30.56	34.2
32	15.50	16.56	20.2				

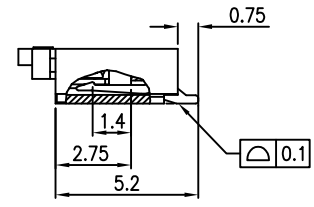
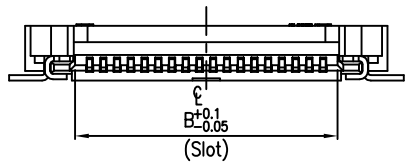
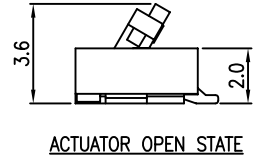
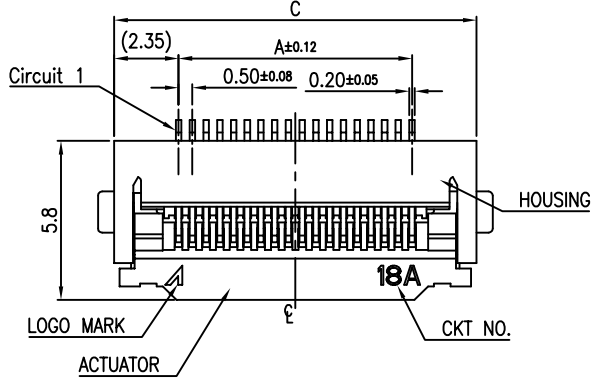
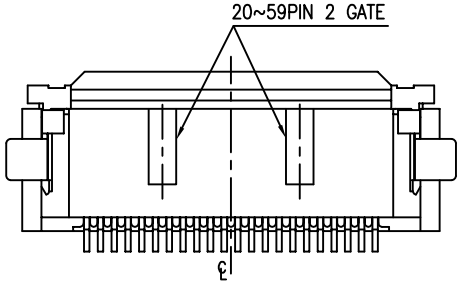
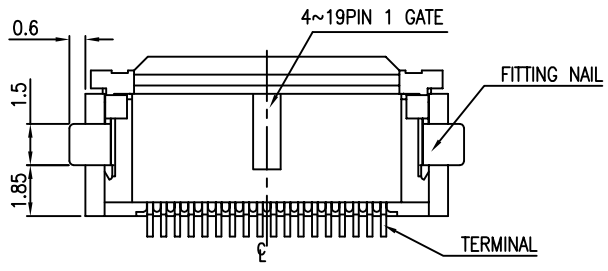

QUALITY SYMBOLS	DRAWN BY	DATE
MAJOR Ⓜ	Sun,Ya Jie	20/04/24
CRITICAL Ⓢ	CHECKED BY	DATE
	Xu,Zhi Yong	20/04/24
GENERAL TOLERANCES (UNLESS SPECIFIED)	APPROVED BY	DATE
X. ±0.5	Xu,Zhi Yong	20/04/24
.X ±0.25		
.XX ±0.15		
.XXX ±0.1		
ANGLES ±2°		

**ACES ELECTRONICS**

TITLE: 0.5 PITCH EASY ON FPC CONN. SMT R/A B/C TYPE

UNITS	SIZE	DWG NO.
mm	A4	51652-XXXXX-XXX
SCALE	SHEET NO.	REV
4:1	1 OF 1	B
		PART NO.
		SEE NOTES